

Article number: 201057300  
Description: E+G Handwheel  
GN 949-125-B14-D

## Measures

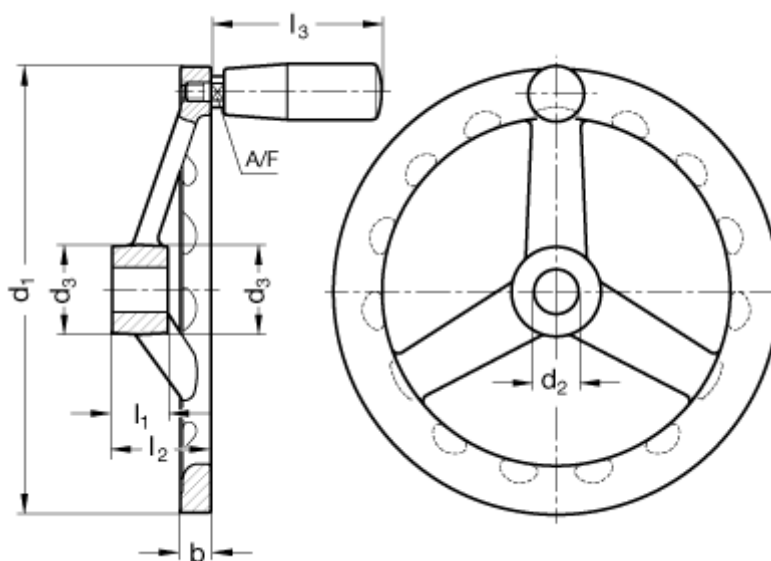

A/F	= 9	l3	= 55
b	= 9	Number of spokes	= 3
d1	= 125		
d2	= 14		
d3	= 24		
Handle diameter	= 21		
l1	= 16		
l2	= 28,5		